



**HIDRAVLIKA, PNEVMATIKA,
STROJEGRADNJA, TRGOVINA, SERVIS**

SI-Otoče 5a, 4244 PODNART

Tel.: +386 4 533 10 39

Fax.: +386 4 533 10 59

KATALOG

HIDRAVLIČNI PRIBOR

TYP 01 BP DVOVIJAČNIK - 60° KONUS, COLSKI

ŠTEVILKA ARTIKLA	OZNAKA ARTIKLA	DN	D1	D2	D3	L1
1000001	01 BP 02*02			R 1/8	R 1/8	24
1000002	01 BP 04*04	06	07	R 1/4	R 1/4	29
1000003	01 BP 06*06	10	10	R 3/8	R 3/8	24
1000004	01 BP 08*08	12	12	R 1/2	R 1/2	38
1000005	01 BP 10*10	16	15	R 5/8	R 5/8	45
1000006	01 BP 12*12	20	18	R 3/4	R 3/4	46
1000007	01 BP 16*16	25	22	R 1	R 1	50
1000008	01 BP 20*20	32	29	R 1 1/4	R 1 1/4	53
1000009	01 BP 24*24	40	37	R 1 1/2	R 1 1/2	55
1000010	01 BP 32*32	50	48	R 2	R 2	80

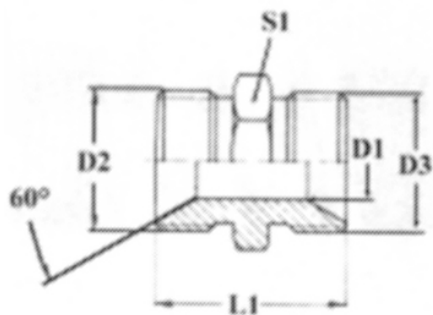

TYP 02 BP DVOVIJAČNIK - 60° KONUS, COLSKI, REDUCIRAN

ŠTEVILKA ARTIKLA	OZNAKA ARTIKLA	DN	D1	D2	D3	L1
1005727	02 BP 04*02			R 1/4	R 1/8	29,5
1000048	02 BP 06*04	10:06	07	R 3/8	R 1/4	32
1000049	02 BP 08*04	12:06	07	R 1/2	R 1/4	37
1000050	02 BP 08*06	12:10	10	R 1/2	R 3/8	37
1000051	02 BP 10*08	16:12	12	R 5/8	R 1/2	41
1000052	02 BP 12*06	20:10	12	R 3/4	R 3/8	42
1000053	02 BP 12*08	20:12	12	R 3/4	R 1/2	43
1000054	02 BP 16*08	25:12	18	R 1	R 1/2	47
1000055	02 BP 16*12	25:20	18	R 1	R 3/4	48
1000056	02 BP 20*16	32:25	21	R 1 1/4	R 1	52
1000055	02 BP 16*12	25:20	18	R 1	R 3/4	48
1000056	02 BP 20*16	32:25	21	R 1 1/4	R 1	52
1005730	02 BP 24*16	38:25		R 1 1/2	R 1	56
1007518	02 BP 24*20	38:32		R 1 1/2	R 1 1/4	58
1007519	02 BP 32*24	50:38		R 2	R 1 1/2	64

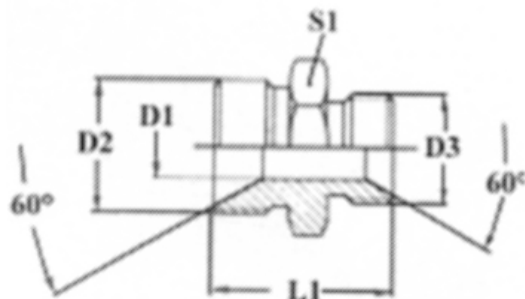

395012 DVOVIJAČNIK - 60° KONUS, METRIČNI / COLSKI NAVOJ

ŠTEVILKA ARTIKLA	OZNAKA ARTIKLA	DN	D1	D2	D3	L1
1001578	39 5012 483 040	5	4	M12 X 1,5	R 1/4	30
1001579	39 5012 483 060	6	5,5	M14 X 1,5	R 1/4	30
1001580	39 5012 483 062	6	6	M14 X 1,5	R 3/8	30
1001581	39 5012 483 080	8	8	M16 X 1,5	R 3/8	30
1001582	39 5012 483 081	8	8	M18 X 1,5	R 3/8	30
1001584	39 5012 483 100	10	8	M18 X 1,5	R 3/8	30
1001585	39 5012 483 101	10	8	M18 X 1,5	R 1/2	30
1001586	39 5012 483 130	12	11	M22 X 1,5	R 1/2	37
1001587	39 5012 483 160	16	14	M26 X 1,5	R 1/2	37
1001588	39 5012 483 161	16	16	M26 X 1,5	R 1/2	39
1001589	39 5012 483 200	20	16	M30 X 1,5	R 3/4	39
1001590	39 5012 483 201	20	20	M30 X 1,5	R 1	41
1001591	39 5012 483 250	25	25	M38 X 1,5	R 1	43
1011367	39 5012 483 251	25	25	M38 X 1,5	R 1 1/4	43
1001592	39 5012 483 320	32	32	M45 X 1,5	R 1 1/4	43
1001593	39 5012 483 321	32	32	M45 X 1,5	R 1 1/2	43
1001594	39 5012 483 400	40	37	M52 X 1,5	R 1 1/2	43
1001595	39 5012 483 500	50	50	M65 X 1,5	R 1 1/2	52
1001596	39 5012 483 600	60	58	M78 X 2,0	R 1 1/2	52

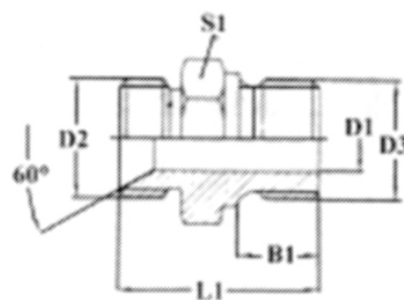

395712 OČESNI PRIKLJUČEK Z NAVOJEM

ŠTEVILKA ARTIKLA	OZNAKA ARTIKLA	DN	D1	D3	D4	B1
1006245	39 5712 483 060	5	4,5	M12 X 1,5	10	10
1001608	39 5712 483 080	6	6	M14 X 1,5	12	10
1001609	39 5712 483 100	8	8	M16 X 1,5	14	11
1001610	39 5712 483 120	10	10	M18 X 1,5	16	11
1001611	39 5712 483 150	12	12	M22 X 1,5	18	12

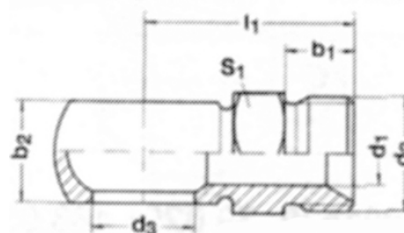

396702 OČESNI PRIKLJUČEK ZA SPJKANJE, DIN 7642

ŠTEVILKA ARTIKLA	OZNAKA ARTIKLA	DN	D1	D3	D4	B1
1001614	39 6702 476 050	03	03	08	05	08
1001615	39 6702 476 060	05	04	10	06	10
1001616	39 6702 476 080	06	06	12	08	12
1006249	39 6702 476 100	08	08	14	10	14
1006250	39 6702 476 120	10	10	16	12	16
1006251	39 6702 476 150	12	13	18	15	20
1008001	39 6702 476 180	16	16	22	18	25
1006252	39 6702 476 220	20	20	26	22	30
1006253	39 6702 476 280	25	26	30	28	36

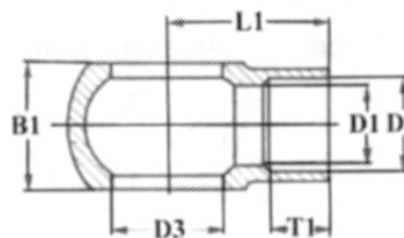

386730 DVOJNI OČESNI PRIKLJUČEK ZA SPAJKANJE, DIN 7462

ŠTEVILKA ARTIKLA	OZNAKA ARTIKLA	DN	D1	D3	D4	B1
1001497	38 6703 477 020	02	03	08	05	08
1001498	38 6730 477 040	04	04	10	06	10
1006208	38 6730 477 080	08	08	14	10	14

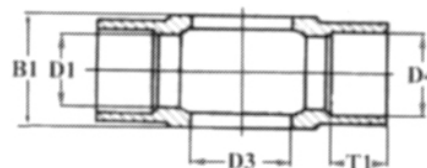

390205 VOTLI VIJAK – METRIČNI, DIN 7643

ŠTEVILKA ARTIKLA	OZNAKA ARTIKLA	DN	D1	D2	L1	S1
1001511	39 0205 483 040	03	04	M08 X 1,0	17	12
1001512	39 0205 483 060	05	5,5	M10 X 1,0	19	14
1001513	39 0205 483 080	06	07	M12 X 1,5	24	17
1001514	39 0205 483 100	08	09	M14 X 1,5	26	19
1001515	39 0205 483 120	10	11	M16 X 1,5	28	22
1001516	39 0205 483 151	12	13	M18 X 1,5	32	24
1001517	39 0205 483 181	16	16	M22 X 1,5	39	27
1001518	39 0205 483 220	20	20	M26 X 1,5	45	32
1007987	39 0205 783 280	25	51	M30 X 1,5	51	36

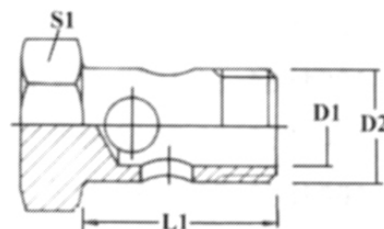

390251 VOTLI VIJAK – METRIČNI/ DVOJNI

ŠTEVILKA ARTIKLA	OZNAKA ARTIKLA	DN	D1	D2	L1	S1
1001520	39 0251 483 030	03	04	M08 X 1,0	26	12
1001521	39 0251 483 040	05	5,5	M10 X 1,0	30	14
1001522	39 0251 483 060	06	07	M12 X 1,5	38	17
1001523	39 0251 483 080	08	09	M14 X 1,5	42	19
1001524	39 0251 483 100	10	11	M16 X 1,5	46	22
1001525	39 0251 483 130	12	13	M18 X 1,5	54	24

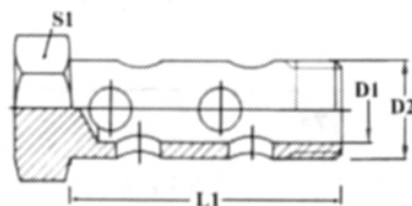

380221 VOTLI VIJAK – COLSKI

ŠTEVILKA ARTIKLA	OZNAKA ARTIKLA	DN	D1	D2	L1	S1
1001435	38 0221 483 040	05	5,5	R 1/8	19	14
1001436	38 0221 483 080	08	9	R 1/4	26	19
1001437	38 0221 483 100	10	11	R 3/8	28	22
1001438	38 0221 483 130	12	12	R 3/8	34	24

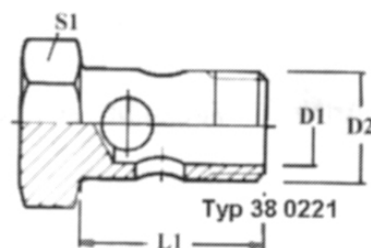

SAE 3000 SAE POLPRIROBNICA SAE J518

ŠTEVILKA ARTIKLA	OZNAKA ARTIKLA	DN	D8	E3	D9	PN
1006258	39 9140 658 080	12	9	38,1	62	350
1006259	39 9140 658 120	20	10,5	47,6	74	350
1006260	39 9140 658 160	25	10,5	52,4	82	350
1006261	39 9140 658 200	1 1/4	12	58,7	92	280
1006262	39 9140 658 240	40	13,5	69,9	108	210
1001632	39 9140 658 320	50	13,5	77,8	118	210

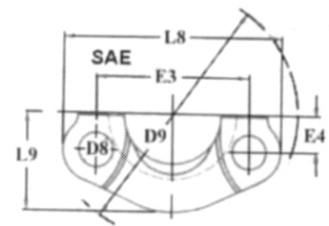

SAE 6000 SAE POLPRIROBNICA SAE J518

ŠTEVILKA ARTIKLA	OZNAKA ARTIKLA	DN	D8	E3	D9	PN
1001622	39 9138 658 080	12	11	50,8	78	415
1006254	39 9138 658 120	12	11	50,8	78	415
1006255	39 9138 658 160	25	13	57,2	90	415
1006256	39 9138 658 200	32	15	66,7	104	415
1001626	39 9138 658 240	40	17	79,4	124	415
1006257	39 9138 658 320	50	21	96,8	146	415

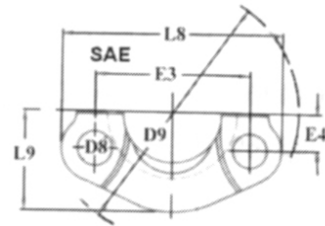

DK DVOJNI KONUS

ŠTEVILKA ARTIKLA	OZNAKA ARTIKLA	DN	D1	L1
1001571	39 1402 855 004	3	4	4,6
1001572	39 1402 855 005	4	5	5,2
1001573	39 1402 855 006	5	6	6,8
1001574	39 1402 855 008	6	8	6,6
1001575	39 1402 855 010	8	10	7,6
1001576	39 1402 855 012	10	12	8,2

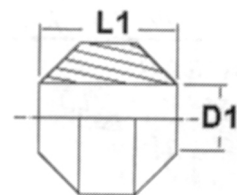

OR O-TESNILO

ŠTEVILKA ARTIKLA	OZNAKA ARTIKLA	D1	D2	TRDOTA	MATER.	DN
1001564	39 1324 936 188	18,6	3,5	85	Perbunan	12
1001565	39 1324 936 253	25	3,5	85	Perbunan	20
1001566	39 1324 936 328	32,9	3,5	85	Perbunan	25
1001567	39 1324 936 378	37,7	3,5	85	Perbunan	32
1001568	39 1324 936 478	47,2	3,5	85	Perbunan	40

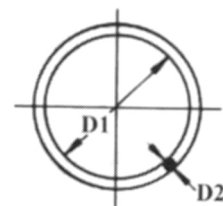

WGA 2AG DVOVIJAČNIK ZA PRALNE STROJE Z ZUNANJIM NAVOJEM

ŠTEVILKA ARTIKLA	OZNAKA ARTIKLA	AG	AG	MATER.
1005267	DVOVIJAČNIK AG 1/2 X 22*1,5	R 1/2	M22 X 1/5	Medenina
1013606	DVOVIJAČNIK AG 1/4 X 22*1,5	R 1/4	M22 X 1/5	Medenina

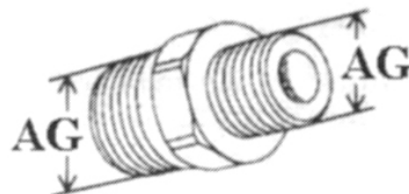

WGA AGÜM PRIKLJUČEK ZA PRALNE STROJE Z ZUNANJIM NAVOJEM IN MATICO

ŠTEVILKA ARTIKLA	OZNAKA ARTIKLA	AG	ÜM	MATER.
1013609	PRIKLJUČEK AG 1/4 X UM22*1,5	R 1/4	M22 X 1/5	Medenina
1011908	PRIKLJUČEK AG 3/8 X UM22*1,5	R 3/8	M21 X 1/5	Medenina
1005269	PRIKLJUČEK AG 3/8 X UM22*1,5	R 3/8	M22 X 1,5	Medenina

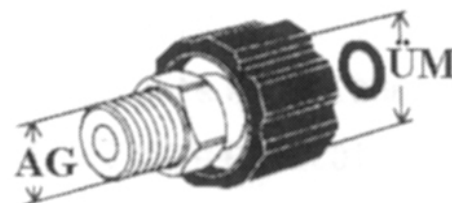

WGA DN2AG DVOVIJAČNIK ZA PRALNE STROJE Z ZUNANJIM NAVOJEM

ŠTEVILKA ARTIKLA	OZNAKA ARTIKLA	AG	AG	MATER.
1005277	DVOVIJAČNIK 21*1,5 X 21*1,5	M21 X 1,5	M21 X 1,5	Medenina
1005278	DVOVIJAČNIK 22*1,5 X 21*1,5	M22 X 1,5	M22 X 1,5	Medenina
1005279	DVOVIJAČNIK 22*1,5 X 22*1,5	M22 x 1,5	M22 X 1,5	Medenina

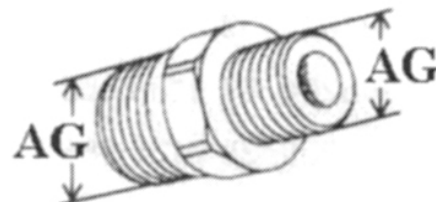

WGA IGAG DVOVIJAČNIK ZA PRALNE STROJE Z NOTRANJIM NAVOJEM

ŠTEVILKA ARTIKLA	OZNAKA ARTIKLA	IG	AG	MATER.
1013607	DVOVIJAČNIK IG 1/4 X 22*1,5	R 1/4	M22 X 1,5	Medenina
1005270	DVOVIJAČNIK IG 3/8 X AG21*1,5	R 3/8	M21 X 1,5	Medenina
1005271	DVOVIJAČNIK IG 3/8 X AG22*1,5	R 3/8	M22 X 1,5	Medenina

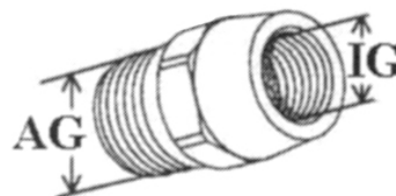

WGA IGOV HITRA SKLOPKA Z NOTRANJIM NAVOJEM ALI Z ZUNANJIM NAVOJEM

ŠTEVILKA ARTIKLA	OZNAKA ARTIKLA	DN	PN	MATER.
1005274	SKLOPKA ŽENSKI DEL	R 3/8	280	Medenina
1005275	SKLOPKA MOŠKI DEL	R 3/8	280	Medenina

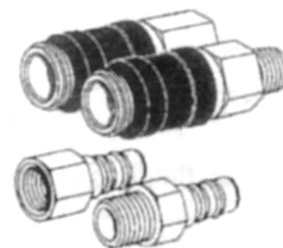

WGA IGÜM PRIKLJUČEK ZA PRALNE STROJE Z NOTRANJIM NAVOJEM IN MATICO

ŠTEVILKA ARTIKLA	OZNAKA ARTIKLA	IG	ÜM	MATER.
1013608	PRIKLJUČEK IG 1/4 X UM22*1,5	R 1/4	M22 X 1,5	Medenina
1005272	PRIKLJUČEK IG 3/8 X UM21*1,5	R 3/8	M21 X 1,5	Medenina
1005273	PRIKLJUČEK IG 3/8 X UM22*1,5	R 3/8	M22 X 1,5	Medenina

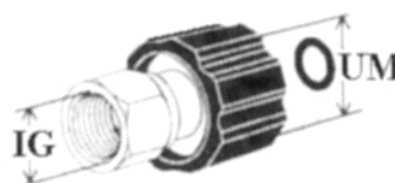

3111 TEMPERATURNA ZAŠČITA

S silikonom impregnirano stekleno vlakno do max. 300°C.
Delovna temperatura: od - 60° do + 250°C.

ŠTEVILKA ARTIKLA	OZNAKA ARTIKLA	ID
1001193	31 1115 000 000	15
1001194	31 1118 000 000	18
1001195	31 1120 000 000	20
1001196	31 1125 000 000	25
1001197	31 1130 000 000	30
1001198	31 1132 000 000	32
1001199	31 1135 000 000	35
1001200	31 1140 000 000	40
1001201	31 1142 000 000	42
1001202	31 1150 000 000	50

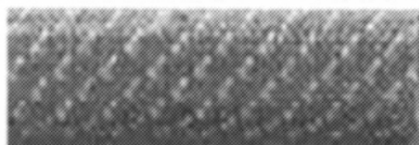

97 2502 PVC ZAŠČITNA CEV PO DIN 40621/2

Delovna temperatura: od - 40° do + 80 °C.

ŠTEVILKA ARTIKLA	OZNAKA ARTIKLA	ID	S
1002550	97 2502 157 170	17	1,2
1002551	97 2502 157 170	19	1,2
1002552	97 2502 157 220	22	1,2

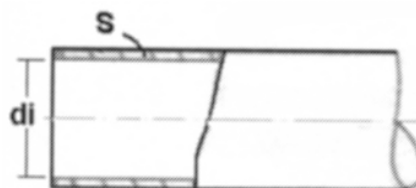

97 2732 ZAŠČITNA SPIRALA

Delovna temperatura: - 40°C do + 100°C
Za kratek čas do +120°C

ŠTEVILKA ARTIKLA	OZNAKA ARTIKLA	ID mm	PREMER UPORABE	MATERIAL
1001805	60021-rumen	17	15-25	Politilen
1012360	60021-črna	17	15-25	Politilen
1001806	60025-rumen	20	17-28	Politilen
1012359	60025-črn	20	17-28	Politilen
1001807	60032-rumen	26	22-40	Politilen
1001808	60032-črn	26	22-40	Politilen
1001809	60054-rumen	47	40-55	Politilen
1001810	60075-rumen	66	55-70	Politilen
1001811	60096-rumen	86	70-90	Politilen
1001812	60110-rumen	99	80-100	Politilen
1013265	60110-črn	99	80-100	Politilen
1001813	60140-rumen	127	95-130	Politilen
1001814	60160-rumen	147	120-150	Politilen
1001815	60200-črn	187	140-190	Politilen
1002553	97 2732 160 070		9-25	Poliamid
1002554	97 2732 160 100		od 25	Poliamid



KS ZAŠČITNA VZMET

ŠTEVILKA ARTIKLA	OZNAKA ARTIKLA	ID	MATERIAL
1004708	KS 16,5	16,5	Pocinkano jeklo
1004714	KS 20,5	20,5	Pocinkano jeklo
1004732	KS 23,0	23	Pocinkano jeklo
1004743	KS 26,0	26	Pocinkano jeklo
1013950	KS 29,5	29,5	Pocinkano jeklo
1004750	KS 33,5	33,5	Pocinkano jeklo
1004752	KS 41,0	41	Pocinkano jeklo
1013966	KS 51,5	51,5	Pocinkano jeklo

